











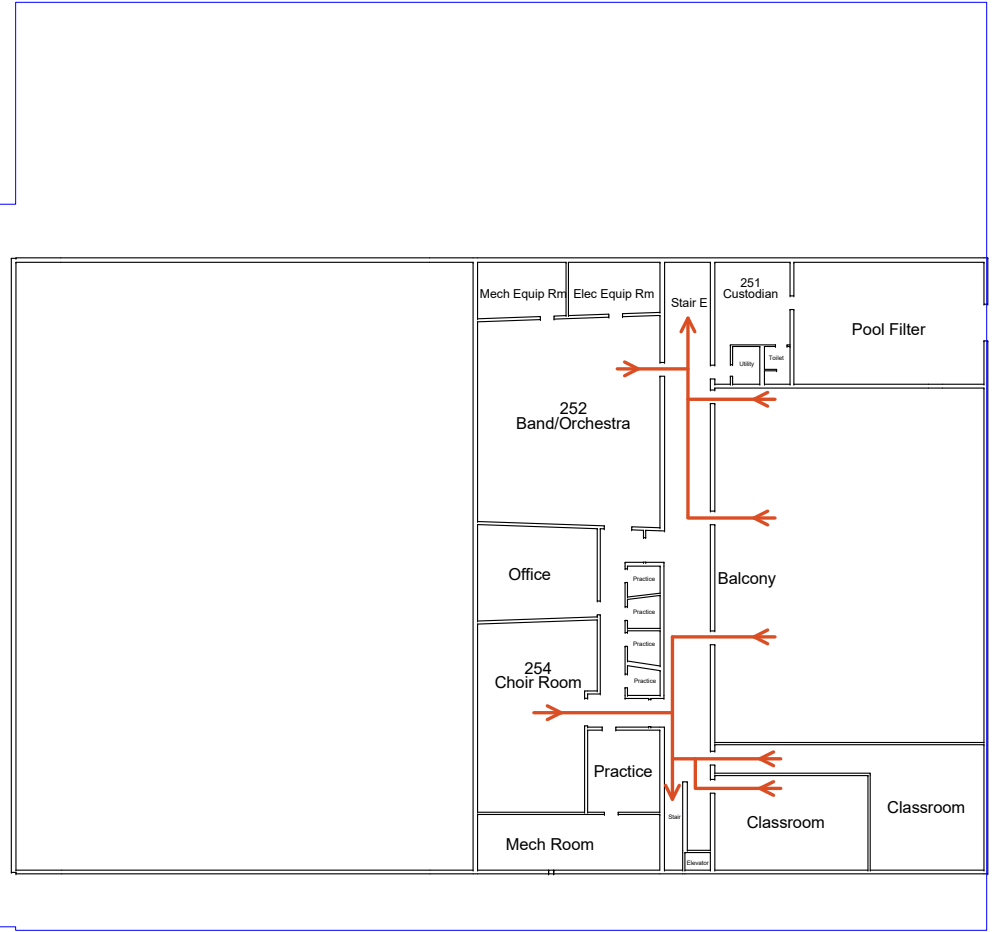
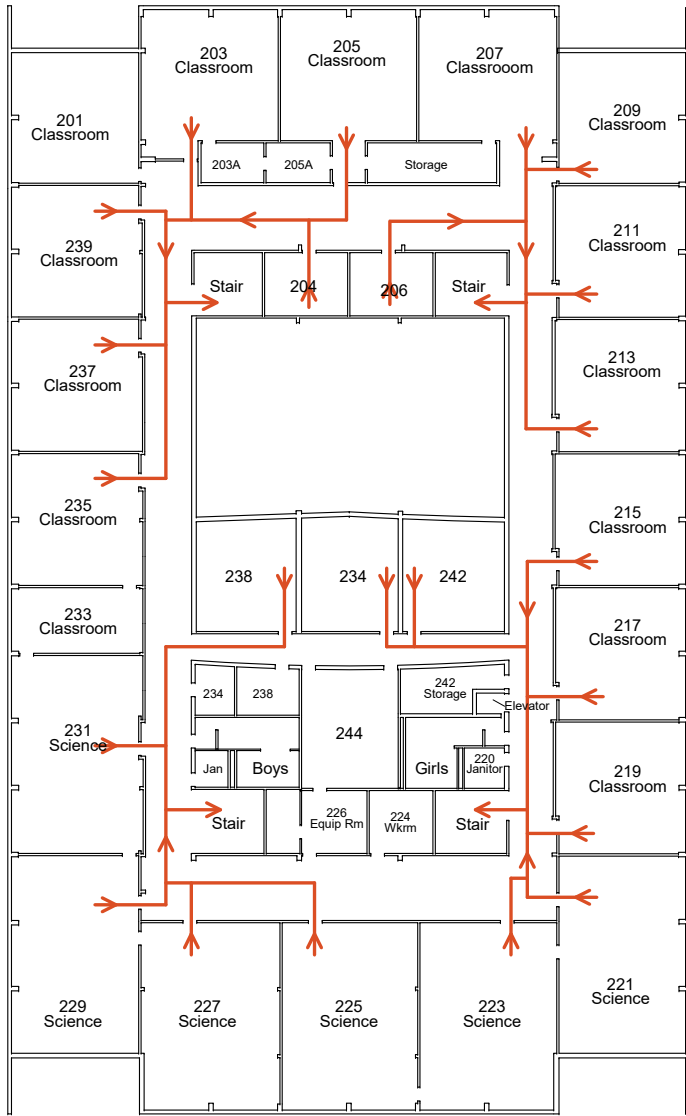

-  YOU ARE HERE
-  Fire Evacuation Routes
-  AED Locations
-  Exterior Door Numbers

	South JH	09/19/2016	
	Level 1 - Fire Evacuation Routes AED	1" = 42'-0"	



	South JH	09/19/2016	
	Level 2 - Fire Evacuation Routes AED	1" = 42'-0"	

-  YOU ARE HERE
-  Fire Evacuation Routes
-  AED Locations
(1st Floor Health Office & Swimming Pool)
-  Exterior Door Numbers