











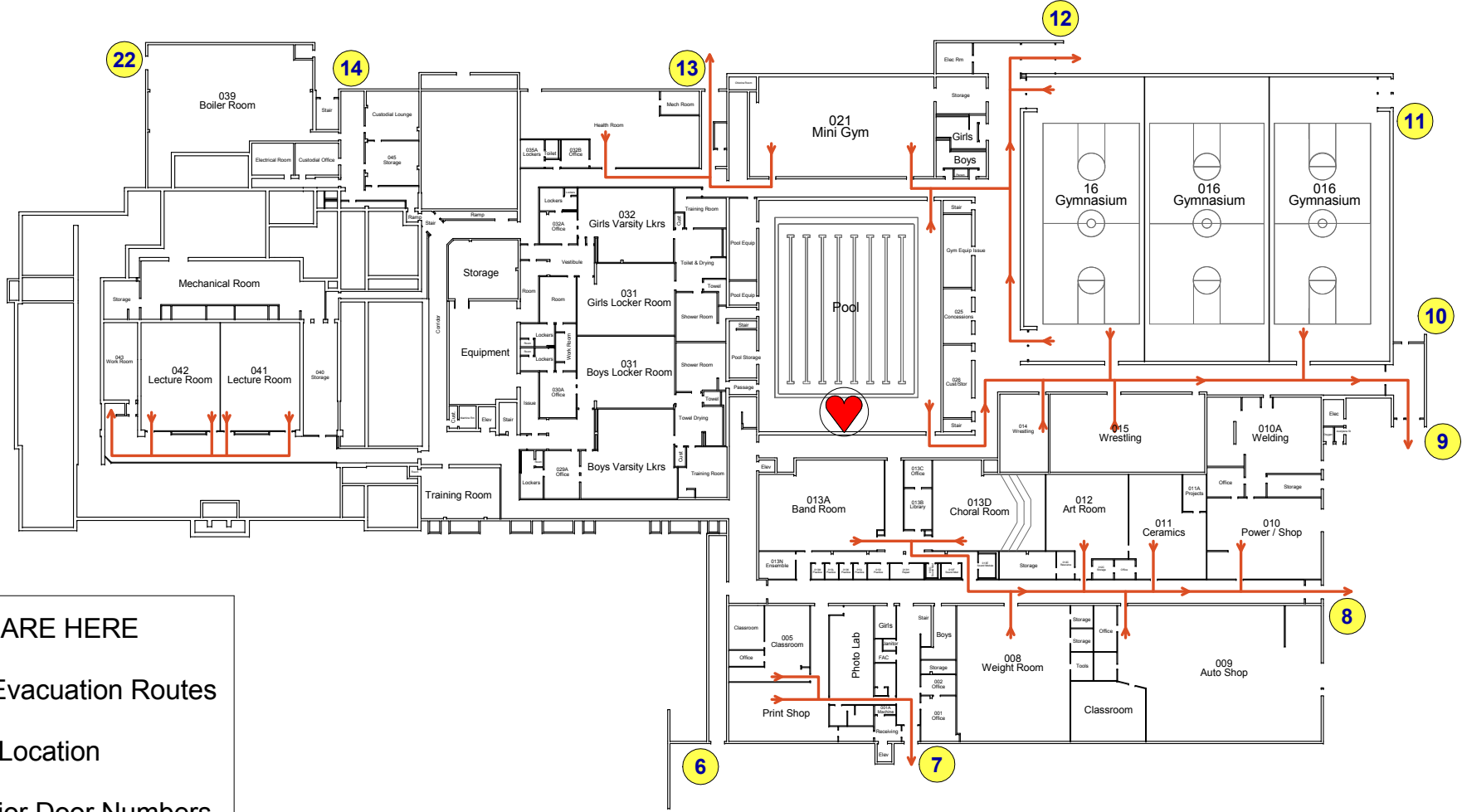
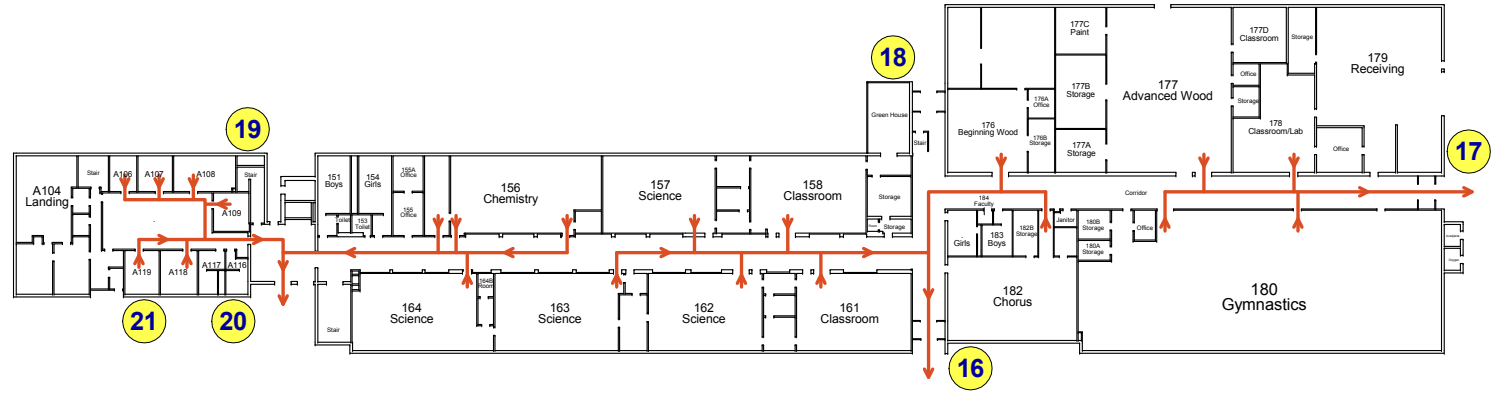

-  YOU ARE HERE
-  Fire Evacuation Routes
-  AED Location (Located on Level 1)
-  Exterior Door Numbers

	Technical High School	6/30/2015	
	Basement - Fire Evacuation Routes	1" = 70'-0"	





-  YOU ARE HERE
-  Fire Evacuation Routes
-  AED Location
-  Exterior Door Numbers

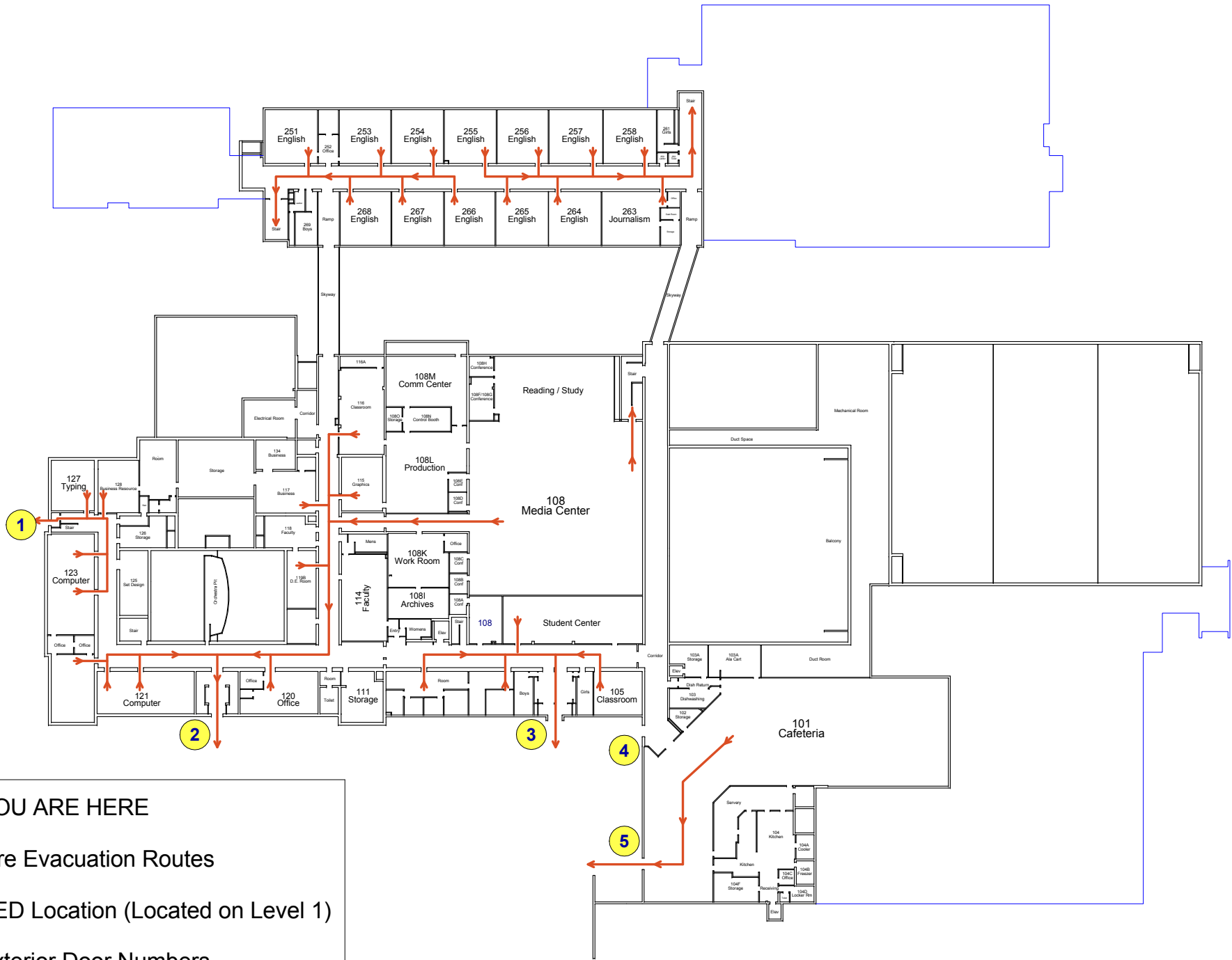

	Technical High School	6/30/2015	
	Level 1 Fire Evacuation Routes	1" = 70'-0"	



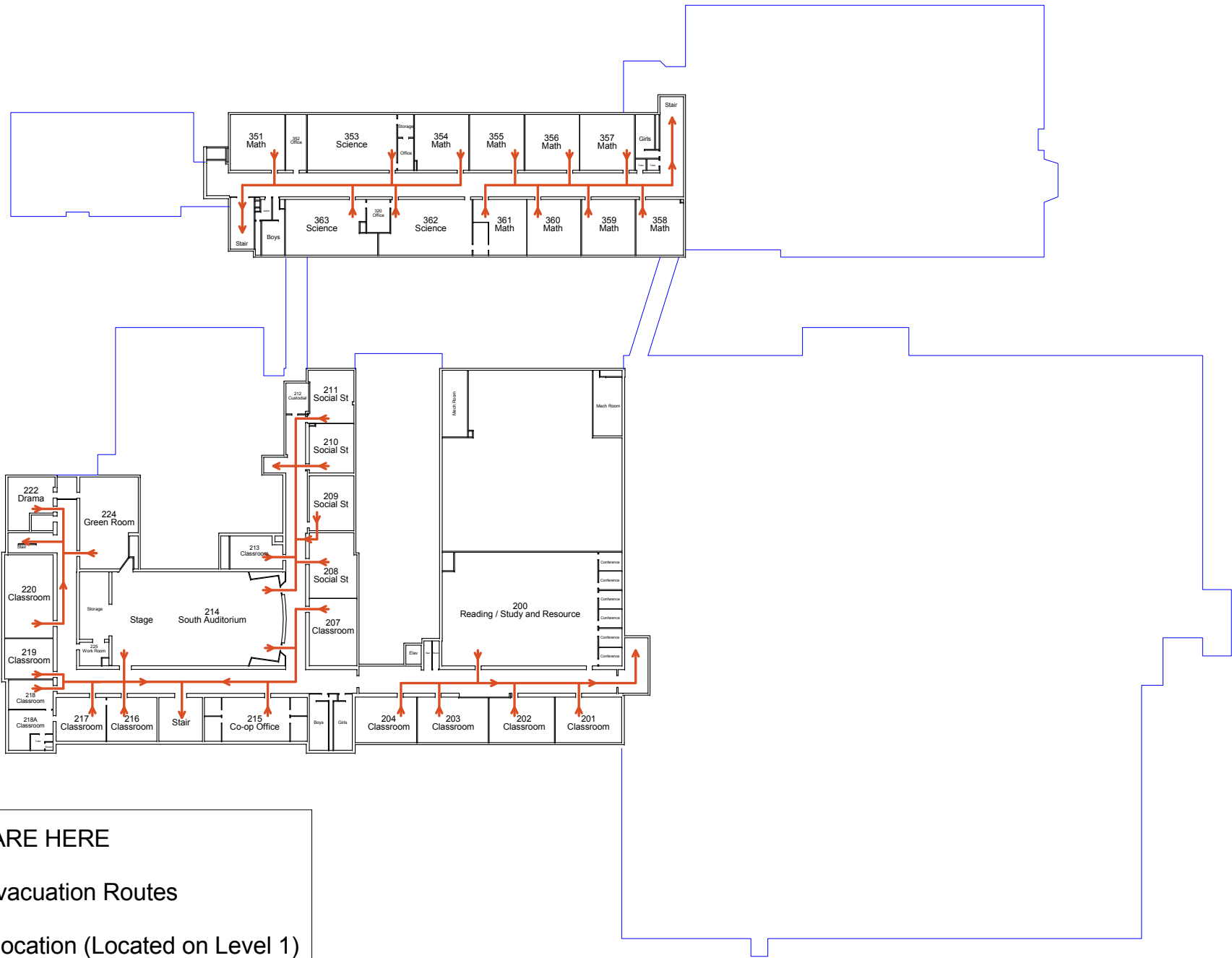

- YOU ARE HERE
- Fire Evacuation Routes
- ♥ AED Location (Located on Level 1)
- 1 Exterior Door Numbers



	Technical High School	6/30/2015	
	Level 2 - Fire Evacuation Routes	1" = 70'-0"	



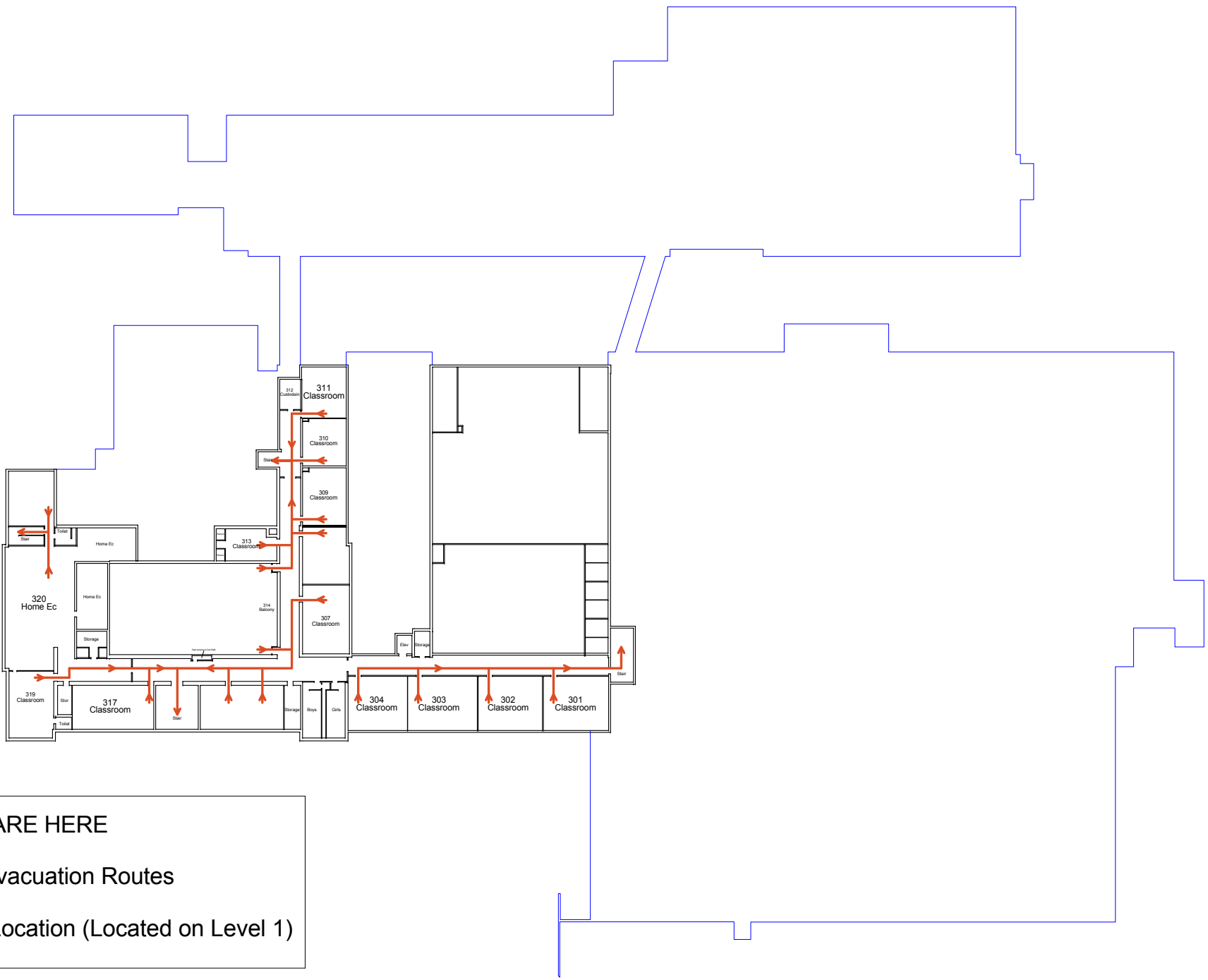

 YOU ARE HERE
 Fire Evacuation Routes
 AED Location (Located on Level 1)

	Technical High School	6/30/2015	
	Level 3 - Fire Evacuation Routes	1" = 70'-0"	



-  YOU ARE HERE
-  Fire Evacuation Routes
-  AED Location (Located on Level 1)

	Technical High School	6/30/2015	
	Level 4 - Fire Evacuation Routes	1" = 70'-0"	